

**OWNER'S
MANUAL**



**SCION xB
HEADREST DVD REAR SEAT ENTERTAINMENT SYSTEM**

INTRODUCTION

Your vehicle is equipped with a Headrest DVD Rear Seat Entertainment System (RSE). The system is designed to give you and your passengers many years of video and audio entertainment in a mobile environment. The system allows you to listen to audio CD's and watch DVD's. Video cameras as well as a variety of standard video games can be used with this system. The DVD player is capable of playback of standard DVD's, CD's and CD-R/RW media. This includes CD's with MP3 format.

Please review this Owner's Manual to become familiar with the features and controls as well as the very important safety information. Please review User Manuals for video games and video game equipment when used as auxiliary inputs for your Head Rest Rear Seat Entertainment System. Please read all of the safety and operating instructions before operating the system and retain for future reference.

Federal Communication Commission (FCC) Compliance

Changes or modifications not approved could void user's authority to operate the equipment. This equipment has been tested and found to comply with the limits for a Class B digital device, pursuant to Part 15 of the FCC Rules. These limits are designed to provide reasonable protection against harmful interference in a residential installation. This equipment generates, uses and can radiate radio frequency energy and, if not installed and used in accordance with the instructions, may cause harmful interference and radio communications. If this equipment does cause harmful interference to radio or television reception, which can be determined by turning the equipment off and on, the user is encouraged to consult their Toyota dealer.

SAFETY PRECAUTIONS

This manual contains certain CAUTION and NOTICE Warnings that are used to prevent or reduce the chance of injury or damage to passengers and vehicle equipment, respectively. If you are driving a TOYOTA with a RSE system, please adhere to the following guidelines:

CAUTION

This is a WARNING against something that may cause injury to passengers if the warning is ignored. You are informed what you must or must not do in order to avoid or to reduce the risk of injury to yourself and others.

NOTICE

This is a WARNING against something that may cause damage to the vehicle or its equipment if the warning is ignored. You are informed what you must or must not do in order to avoid or to reduce the risk of causing damage to the vehicle or its equipment

CAUTION

For safety reasons, when changing video media it is recommended that the vehicle is not in motion and that you do not allow children to unfasten seat-belts to change video media or make any adjustments to the system except through the remote control. System adjustments can be accomplished using the remote control unit, while seat-belts remain fastened. Enjoy your entertainment system and remember the safety of all of the passengers in the vehicle should always remain the number one priority.

CAUTION

The driver must not attempt to operate any function of the DVD system while the vehicle is in motion. Give full attention to driving and to the road. Pull off the road and park in a safe place before inserting or extracting DVD's from the system. A remote control is included with the system to allow the rear seat occupants to operate most system functions without distracting the driver or removing seat belts.

⚠ CAUTION

Conversational speech on some DVDs is recorded at a low volume to emphasize the impact of sound effects. If you adjust the volume assuming that the conversations represent the maximum volume level available for the DVD, you may be startled by the louder sound effects or when you change to a different audio source. Loud sounds may have a significant impact on the human body or pose a driving hazard. Keep this in mind when you adjust the volume.

⚠ CAUTION

Before putting on Headphones always adjust the volume setting to the lowest position.

⚠ CAUTION

1. Keep the monitor clean and dry.
2. Always seek qualified personnel to perform repairs. Never attempt your own repairs.
3. Do not drop the monitor or expose the monitor to strong impacts.
4. Do not expose the monitor to direct sunlight for extended periods of time.

⚠ CAUTION

The front glass on the liquid crystal display (LCD) screen may break when hit with a hard object. If the glass breaks, do not touch the liquid crystalline material. In case of contact with skin, wash immediately with soap and water. Caution children to avoid touching or scratching the screen, as it may become dirty or damaged.

NOTICE

Do not operate video games or video equipment if the power cords and/or cables are broken, split or damaged. Carefully place cords and/or cables where they will not be stepped on or interfere with the operation of seats and/or compartments. Disconnect video games and video equipment power cords and/or cables when not in use. Do not allow the auxiliary input jack to get wet or dirty. Do not clean any part of the DVD player/screen with benzene, paint thinner or any other solvent.

NOTICE

Do not use any solvents or cleaning materials when cleaning the LCD display. Do not use any abrasive cleaners, they may scratch the screen. Use only a lightly dampened lint free cloth to wipe the screen if it is dirty.

NOTICE

Moisture in the air will condense in the DVD player under extremely humid conditions or when moving from a cold place to a warm one. Moisture condensation may cause damage to the DVD and/or player. If moisture condensation occurs, do not insert a CD or DVD into the player. If one is already in the player, remove it. Turn the DVD player ON to dry the moisture before inserting a DVD. This could take an hour or more.

NOTICE

Exercise care to prevent dirt and foreign objects from entering the DVD player compartment. Be especially careful not to spill liquids of any kind onto the media controls or into the system. If liquid is accidentally spilled onto the system, immediately turn the system OFF and consult a qualified service technician.

NOTICE

When the vehicle is parked in direct sunlight or in an extremely cold place for a long period of time, wait until the cabin temperature of the vehicle is at a comfortable temperature before operating the system.

NOTICE

Lock the LCD screens in the fully closed position when not in use.

NOTICE

The use of a cellular phone inside or near the vehicle may cause noise or audio interference from the speakers of the system, which you are listening to. However, this does not indicate a malfunction.

NOTICE

Do not play the Rear Seat Entertainment System for extended periods of time with the engine shut off as this will drain the battery.

NOTICE

Do not attempt to service, repair or modify the Rear Seat Entertainment System. See your dealer if service is needed.

NOTICE

Do not insert foreign objects into the DVD openings.

NOTICE

Do not expose the liquid crystal display (LCD) screen to direct sunlight or intensive ultraviolet rays for extensive periods of time. Ultraviolet rays deteriorate the liquid crystal.

TABLE OF CONTENTS

| | | | |
|---|-------------|---------------------------------------|--------------|
| INTRODUCTION | I | Settings and Adjustments | 13 |
| Federal Communication Commission (FCC) Compliance | I | Using the Setup Menu | 13 |
| SAFETY PRECAUTIONS | II-V | Exiting the Setup Menu | 13 |
| QUICK START GUIDE | 1 | Language Setup | 13 |
| Operating the DVD System | 1 | Language for On-Screen Display | 13 |
| CONTROLS AND INDICATOR DIAGRAM | 2 | Subtitle Setup | 14 |
| Control Function Descriptions for M1 and M2 Monitor | 2 | Audio Setup | 14 |
| M1 / M2 Panel Control | 2 | Video Setup | 15 |
| DVD HEADREST SYSTEM OVERVIEW | 3 | TV Display | 15 |
| REMOTE CONTROL OPERATION | 4 | TV Type | 15 |
| Battery Installation | 4 | Rating Setup | 16 |
| Remote Control Functional Description | 5-9 | Rating | 16 |
| WIRELESS HEADPHONES OPERATION | 10 | Misc Setup | 16 |
| Wireless Headphones Special Features | 10 | Factory Defaults | 16 |
| Wireless Headphone Battery Installation | 10 | Screen Saver | 17 |
| OPERATION INSTRUCTIONS | 11 | Playing Audio CDs | 17 |
| Control Button Functions (M1 / M2 Unit) | 11 | Playing MP3 Discs | 18 |
| DVD Basics | 12 | Selecting a Play Mode | 18 |
| Region Coding | 12 | Skipping Songs | 18 |
| Types of Discs Your System Will Play | 12 | Selecting Folders and Songs | 18 |
| Disc Compatibility | 12 | Program Play | 19 |
| Loading and Playing Discs | 12 | Deleting the Play List | 19 |
| To Load and Play a Disc | 12 | TROUBLESHOOTING | 20 |
| Source Selection | 12 | FUSE REPLACEMENT | 21 |
| | | SPECIFICATIONS | 22 |
| | | OWNER'S NOTES | 23-24 |

QUICK START GUIDE

Operating The DVD System:

1. Turn on the **M1 Monitor** (passenger side) using the Power button on the front of the screen or the *Remote Control. Tilt the screen forward using the center tab at the top of the screen.
2. Insert a DVD, CD or MP3 disc into the slot (disc label toward driver).
3. The disc will start playing.
4. Tilt the monitor to a comfortable viewing position (the headrest itself can be tilted forward to help achieve a comfortable viewing position).
5. When the DVD menu appears, select the menu item using the cursor keys and press the Enter or Play button.
6. Each wireless headphone has a CH A/CH B switch. When sitting in front of the M1 monitor, use the CH A switch setting. When sitting in front of the M2 monitor, use the CH B switch setting. Set the headphone to the proper channel and press the Power On/Off switch. The power indicator will light up red. Turn the volume down to its lowest setting before putting them on your head.
7. If audio playback through the vehicle radio is preferred, set the radio to AUX mode. Verify that nothing is connected to the vehicle radio's AUX jack.
NOTE: If there is a plug in the vehicle radio's AUX jack; it will override the DVD audio.
8. Turn on the **M2 Monitor** (driver's side) using the power button on the front of the screen or remote control.
9. Tilt the screen to a comfortable viewing position (the headrest itself can be tilted forward to help achieve a comfortable viewing position).
10. Select AV1 using the source button on the front panel or remote control to view program material on M1 or select from the other available sources DVD, or AUX for M2 Monitor.

***NOTE:** To operate the M1 screen, press M1 on the remote control. To operate the M2 screen, press M2 on the remote control.

CONTROLS AND INDICATOR DIAGRAM

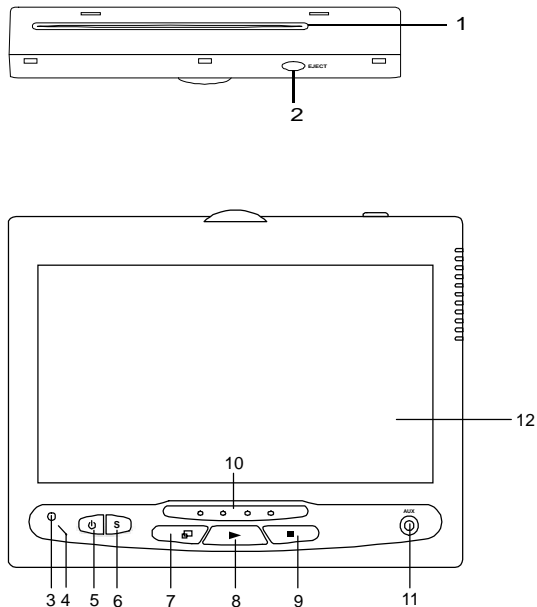

Control Function Descriptions for M1 and M2 Monitor

M1 / M2 Panel Control

1. DVD disc insertion slot (disc label towards driver)
2. EJECT Button
3. Power Indicator LED
4. IR Sensor
5. POWER Button
6. SOURCE Button
7. SCREEN MODE Button (Normal, Wide, Off)
8. PLAY Button
9. STOP Button
10. IR Transmitter LEDs
11. AUX Input Jack (use with supplied AV adaptor)
12. LCD Screen

DVD HEADREST SYSTEM OVERVIEW

1. The DVD Headrest system is a versatile audio / video system which includes two monitors, each with a built-in DVD player.
2. The M1 Monitor (passenger side) is comprised of a 7" TFT LCD monitor with built-in DVD player that allows the user to select from DVD, A/V1, or AUX sources. The M1 monitor has a built-in infrared audio transmitter (CH A) for use with the supplied two-channel wireless headphones (CH A). The M1 monitor also has the ability to provide the audio source for output to allow audio playback through the vehicle radio.
3. The M2 monitor (driver's side) is comprised of a 7" TFT LCD monitor with built-in DVD player that allows the user to select from DVD, A/V1, or AUX sources. The M2 monitor has a built-in infrared audio transmitter (CH B) for use with the supplied two channel wireless headphones (CH B).
4. The monitors will show all of the system functions with the comprehensive On Screen Display (OSD).
5. The DVD Headrest System includes two IR Headphones. The headphones have an A-B switch that allow the users to select the audio from either the M1 (CH A) or the M2 (CH B).
6. Each monitor uses different Remote Control IR codes. The M1 Monitor will only respond to the Remote Control unit when the Monitor Select (M1) button is pressed on remote control. The M2 Monitor will only respond to the Remote Control unit when the Monitor Select (M2) button on remote control is pressed.

7. The M1 and M2 Monitor will accept an audio / video input through the AUX (use with supplied AV adaptor) input located on the front of the unit. The audio / video device could be a video game system, video camera, or other input device.

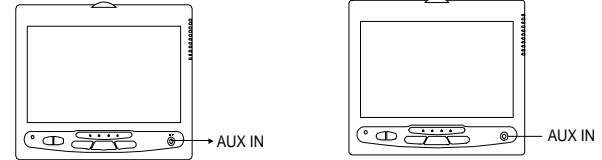

8. Pivot the screen until a comfortable viewing angle reached. The internal lock limits the screen to a maximum adjustment of 30 degrees from closed position, the headrest itself can be tilted forward to help achieve a comfortable viewing position.

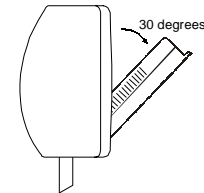

9. Pivot the screen

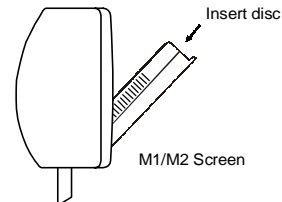

10. Eject disc

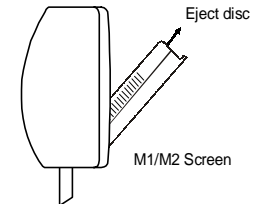

REMOTE CONTROL OPERATION

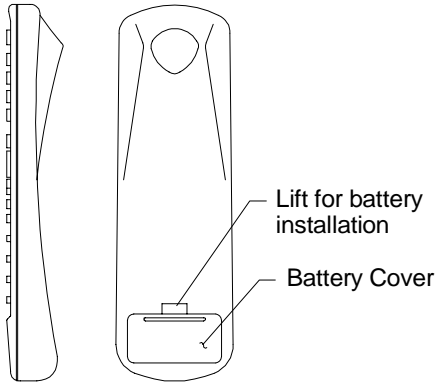

Battery Installation:

Before attempting to operate your remote control, install the batteries as described below.

1. Turn the remote control face down. Using a fingernail, lift the battery cover off.
2. Install two "AAA" batteries. Make sure that proper polarity (+/-) is observed.
3. Align the cover tabs with the remote control and press down until the cover clicks.

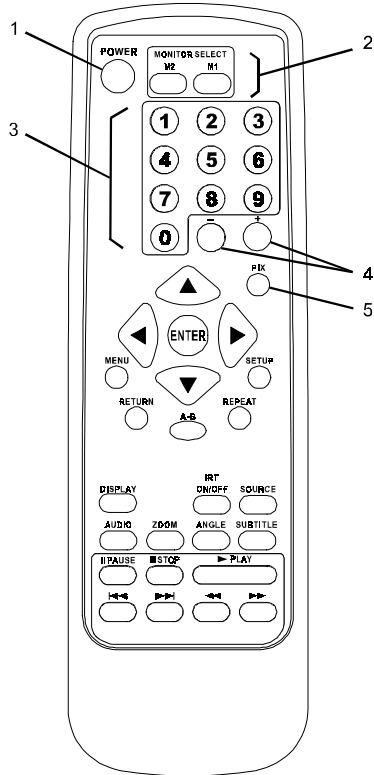

REMOTE CONTROL FUNCTIONAL DESCRIPTION

* Function control is available on the unit and remote control.

1. **POWER Button*** – Press this button to turn M1 or M2 Monitor ON. Press the button again to turn M1 or M2 Monitor OFF.
2. **Monitor Select (M1 and M2 Buttons)** – Press corresponding button to change the Remote Control code to enable control of the M1 or M2 Monitor.
3. **NUMBER Buttons** – Allows the user to enter the numbers 0 to 9 for selection of CD tracks, DVD chapters, and password setting.
4. **UP/DOWN (+/-) Buttons** – Use these buttons to make picture adjustments in the picture select mode.
5. **PIX Button (PICTURE SELECT)** – Each time this button is pressed, the on screen picture adjustment displays the “adjustment bar” for BRIGHTNESS, CONTRAST, COLOR or TINT. Once the desired adjustment bar is displayed, use the (+) / (-) button to adjust the setting. The OSD will automatically turn off if no adjustments are made within 6 seconds, or if any other button is pressed.

NOTE: To control the individual units (M1 Monitor / M2 Monitor) press either M1 or M2 before pressing any other button. For example, to turn M1 Monitor ON, press M1 and then the power button.

Figure 1a. Remote Control

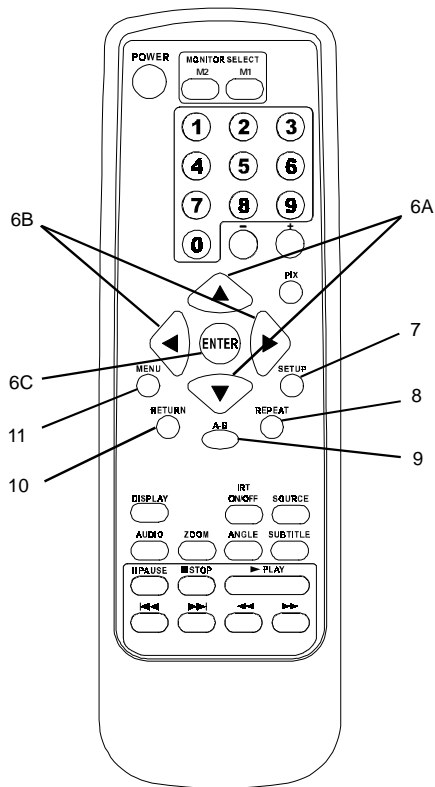

Figure 1b. Remote Control

- 6a. Up (▲)/Down (▼) Buttons – Use these buttons to scroll upward and downward, respectively, in menu options.
- 6b. LEFT (◀)/Right (▶) Buttons – Use these buttons to shift left and right, respectively, in the menu options.
- 6c. ENTER Button – Used to implement a selected setting.
- 7. SETUP Button – Press to display the Setup Menu which allows the user to change the DVD player options such as TV DISPLAY, OSD LANGUAGE, PARENTAL CONTROL etc. Refer to the Settings and Adjustments section for more information.
- 8. REPEAT Button – Allows the user to repeat a selected Title, Chapter or Track of a DVD, CD or MP3. Refer to repeat function in this manual for each type of disc.
- 9. A-B Button – Allow user to repeat the playback from point A to point B.
- 10. RETURN Button – Not used on this model.
- 11. MENU Button – Allows the user to access the DVD (DVD MODE) root menu.

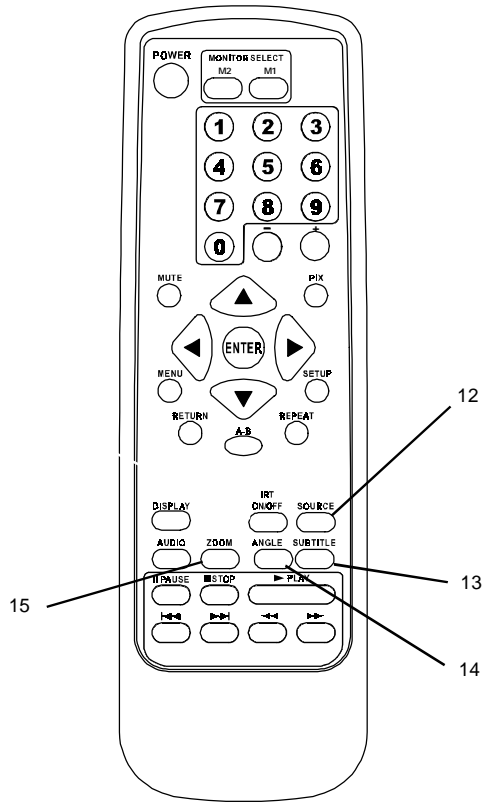

Figure 1c. Remote Control

12. **SOURCE Button*** – Press this button to select the available sources. On the M1 monitor, the sources are DVD, AV1, & AUX. On the M2 Monitor, the sources are DVD, AV1, & AUX.
13. **SUBTITLE Button** – Press to display and select the subtitle language in DVD mode. Each time you press the button, the subtitle language changes.

NOTE: The type and number of languages for subtitles vary from disc to disc.

14. **ANGLE Button** – Press to display and select different camera angles in DVD mode. Each time you press the button, the angle changes.

NOTE: The numbers of angles vary from disc to disc. Not all discs contain this option.

15. **ZOOM Button** – Press this button to enlarge the picture when playing a DVD disc.

Press ZOOM button

Once

Twice

3 times

4 times

DVD Player Performs

Enlarge the picture 2 times of the original size

Enlarge the picture 3 times of the original size

Enlarge the picture 4 times of the original size

Picture is returned to original size

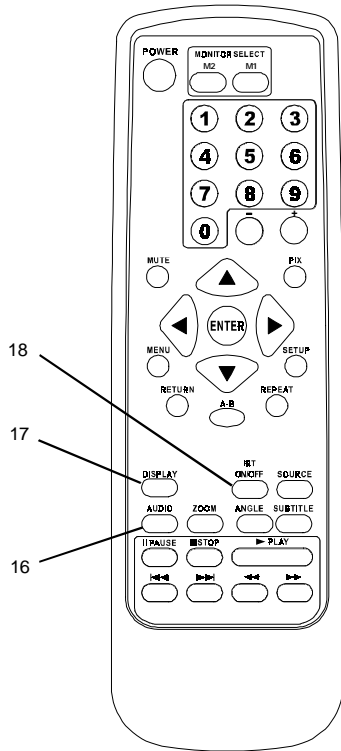

16. **AUDIO Button** – Press to display and select the AUDIO language in DVD mode. Each time you press the button, the language changes.

NOTE: The languages for audio vary from disc to disc.

17. **DISPLAY Button** – Press to display the current disc information while the disc is playing. Press the cursor (▲▼◀▶) buttons to highlight the desired option. For title and chapter selection use the number buttons to enter the desired title or chapter number for angle, audio, and subtitle. Press the ENTER button repeatedly to change the item.

Title
Chapter
Angle
Audio
Subtitle

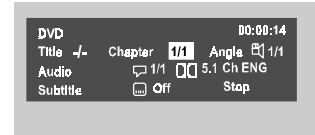

18. **IRT ON/OFF Button** – Press this button to turn the selected unit (M1/M2) IR Transmitter ON/OFF.

Figure 1d. Remote Control

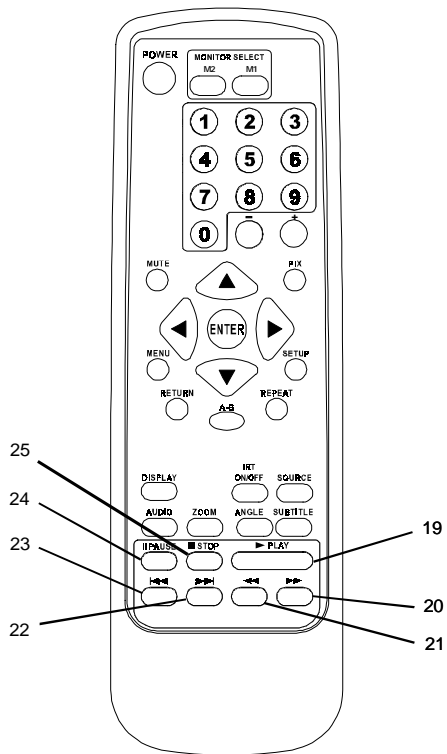

Figure 1e. Remote Control

19. **PLAY (▶) Button*** – Press to activate the play mode while a disc is loaded in the disc compartment.
20. **SCAN FORWARD (▶▶) Button** – Press to search in a forward direction. Press repeatedly to change the search speed from 2, 4, 8, 16 times the normal speed.
21. **SCAN BACKWARD (◀◀) Button** – Press to search in a backward direction. Press repeatedly to change the search speed from 2, 4, 8, 16 times the normal speed.
22. **NEXT (▶▶|) Button** – Press to skip to the next chapter, track or song.
23. **PREVIOUS (|◀◀) Button** – Press to return to the previous chapter, track or song.
24. **PAUSE (II) Button** – Allows the user to pause the playback. Press the Play button to resume normal playback.
25. **STOP (■) Button*** – Press to stop playback.

WIRELESS HEADPHONES OPERATION

The system includes built-in infrared transmitters for use with Wireless Headphones. The master monitor (M1) IR transmitter uses CH A of the wireless headphones. An A-B switch allows the user to select the audio from either the M1 Master (CH A) or the M2 Satellite (CH B).

Wireless Headphones Special Features

- Dual Channel
- Automatic level control prevents input signal overloading.
- Uses high frequency infrared light to assure a clean signal for clear reception.
- Fold-flat ear pieces rotate 90° to facilitate storing in seat back pocket or door pocket.

When sitting in front of the M1 screen, use the CH A switch setting. When sitting in front of the M2 screen, use the CH B switch setting.

To operate the Headphones:

1. Set the headphones to the proper channel and press the Power ON/OFF switch on the right-hand earpiece (Figure 2) to turn the headphones ON. The power indicator will light red.
2. Adjust the Volume level with the VOL Control Dial on the right-hand ear piece (Figure 2) to its lowest setting before putting them on your head.
3. Press the ON/OFF button again to turn the Headphones OFF.

NOTE: The IR transmitter must be in the “ON” mode. See IR Transmitter “Remote Control Functional Description, Item 18.

NOTE: When storing the Wireless Headphones in the seat back pocket or door pocket, pivot the ear pieces to the flat position.

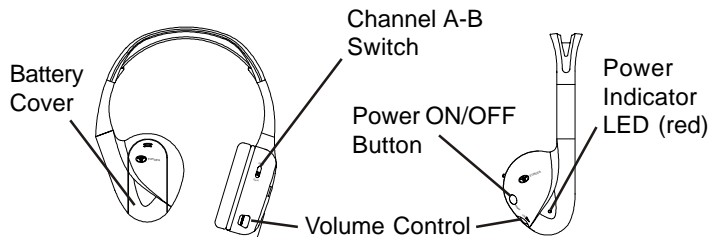

Figure 2. Wireless Headphones Controls and Indicators

Wireless Headphone Battery Installation

1. Remove the Battery Cover and remove old batteries (Figure 3).
2. Place two alkaline AAA batteries into the battery compartment of each Headphone, making sure that the battery polarity is correct.
3. Replace Battery Cover.



Figure 3. Replacing the Headphone Batteries

OPERATION INSTRUCTIONS

Control Button Functions (M1/M2 Unit)

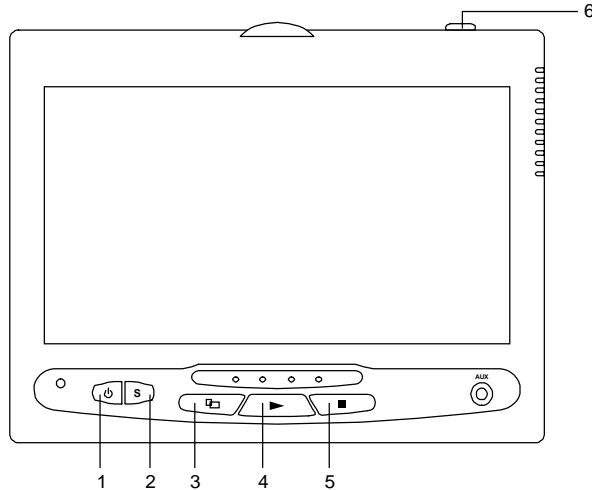

Figure 4. Monitor Button Functions

There are six (6) buttons on the M1 unit and M2 unit:

1. **POWER** Button – Press this button to turn the unit ON/OFF.
2. **SOURCE** Button – Press this button to select between DVD, AV1, and AUX.
3. **SCREEN MODE** Button – Press this button to select between Wide (16:9), Normal (4:3) aspect ratio or screen off (display OFF).
4. **PLAY** Button – Press this button to start playback.
5. **STOP** Button – Press this button to stop playback.
6. **EJECT** Button – Press this button to eject the disc.

DVD Basics

To get the optimum use out of your DVD Headrest System, please read this section completely.

Region Coding

Both the DVD player and DVDs are coded by region. These region codes must match in order for the disc to play. If the codes don't match, the disc won't play. This unit is set to region 1 (USA) and will not play discs that have a region code different from region 1. The unit will display "Wrong Region".

Types of Discs Your System Will Play

- DVD disc* - DVD discs which contain video.
- Audio discs - Audio CDs contain musical or sound content only.
- MP3 discs - A disc that contains audio files (for example, a CD-R with downloaded MP3 files).

* This system is capable of playing most recordable DVD formats. However, due to the variety of disc manufacturers and software, playback cannot be guaranteed for every disc.

Disc Compatibility

Before you load a disc, make sure that it is compatible with the player. Insert the disc with the label facing the driver.

NOTE: The following discs **cannot** be played with this player:

- MiniDisc
- Laserdisc
- CD-I, CD-ROM, DVD-ROM, Super Audio CD (SACD), DVD Audio
- BD (Blue-Ray Disc™) and HD (High Definition) DVD discs

Loading and Playing Discs

To Load and Play a Disc

Press the Power button to turn the unit ON. Pivot the screen forward, select DVD mode and insert the disc (label towards driver) into the disc insertion slot.

Source Selection

M1 Sources:

DVD, AV1, AUX

DVD - Select DVD to view the internal (M1) DVD player.

AV1 - Select AV1 to view the source that is selected on the M2 monitor.

AUX - Select AUX to view the source that is connected to the AUX input* on the front of the unit.

M2 Sources:

DVD, AV1, AUX

DVD - Select DVD to view the internal (M2) DVD player.

AV1 - Select AV1 to view the source that is selected on the M1 monitor.

AUX - Select AUX to view the source that is connected to the AUX input* on the front of the unit.

*The AUX input requires the use of the supplied AV adapter cable (1/8"-to-RCA). Plug the external source into the 3 RCA jacks (red-to-red, white-to-white, yellow-to-yellow) and plug the 1/8" plug into the AUX jack on the front of the screen.

SETTINGS AND ADJUSTMENTS

The Setup Menu contains features and options that let you customize your DVD player. For example, you can set a language for the on-screen display and limit playback of disc content for children.

Using the Setup Menu

1. Press the SETUP button on the remote. The Setup Menu appears on the screen as shown in the diagram.

| | |
|----------|----------------|
| Language | Language Setup |
| Video | Video Setup |
| Rating | Rating Setup |
| Misc | Misc Setup |

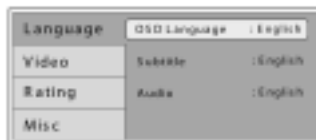

2. To select the desired function, move the highlight using the cursor button ▲ or ▼ to the function indicated.
3. After entering the desired function, highlight the desired item using the cursor button ◀ or ▶.
4. Press ▶ to move the highlight to the different options for the selected item. Press ▲ or ▼ to select the desired options and then press ENTER to confirm the selection.
5. To change to another function, press ◀ until the highlight moves back to the function item of the Setup Menu.

Exiting the Setup Menu

Press the SETUP button to exit.

LANGUAGE SETUP

Language for On-Screen Display

OSD MENU: The OSD MENU setup allows the user to select the language for the on-screen display. The user can select English, French, Spanish, German or Italian for the OSD language.

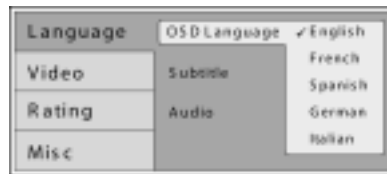

1. While in the Language Setup, highlight OSD LANGUAGE using the cursor button ▶.
2. Press ▶ to move the highlight to the different options for the selected item. Press ▲ or ▼ to select the desired options and then press ENTER to confirm the selection.
3. Press the cursor button ◀ to return to the function setup page.

SUBTITLE SETUP

The SUBTITLE Menu allows the user to select the language of the subtitles appearing on the DVD screen.

NOTE: The type and number of languages for subtitles vary from disc to disc.



1. While in the Language Setup use the cursor button ►.
2. Use the ▲ or ▼ to select SUBTITLE.
3. Press ► to move the highlight to the different options for the selected item. Press ▲ or ▼ to select the desired options and then press ENTER to confirm the selection.
4. Press the cursor button ◀ to return to the function setup page.

AUDIO SETUP

The AUDIO Menu allows the user to select the language of the audio contained on the DVD screen.

NOTE: The type and number of languages for audio vary from disc to disc.



1. While in the Language Setup use the cursor button ►.
2. Use the ▲ or ▼ to select AUDIO.
3. Press ► to move the highlight to the different options for the selected item. Press ▲ or ▼ to select the desired options and then press ENTER to confirm the selection.
4. Press the cursor button ◀ to return to the function setup page.

VIDEO SETUP

TV Display

The TV DISPLAY setup allows you to adjust screen setting (aspect ratio).

4:3 LB

This displays the wide picture with black bands on the upper and lower portions of the screen.

16:9

This displays a wide picture with black bands on the upper and lower portion of the screen. The width of the bands will vary, depending on the aspect ratio of the disc.



1. While in the Video Setup use the cursor button ►.
2. Use the ▲ or ▼ to select TV DISPLAY.
3. Press ► to move the highlight to the different options for the selected item. Press ▲ or ▼ to select the desired options and then press ENTER to confirm the selection.
4. Press the cursor button ◀ to return to the function setup page.

TV Type

The TV TYPE setup allows you to select the color system. Default setting is NTSC and should not be changed.

NTSC - Select this type for NTSC TV

PAL - Select this type for PAL TV

MULTI - Select this type for Auto selection mode



1. While in the Video Setup use the cursor button ►.
2. Use the ▲ or ▼ to select TV TYPE.
3. Press ► to move the highlight to the different options for the selected item. Press ▲ or ▼ to select the desired options and then press ENTER to confirm the selection.
4. Press the cursor button ◀ to return to the function setup page.

RATING SETUP

Rating

This setting allows you to limit playback of certain discs depending on the disc rating. If the unit is set to a "G" rating, it will not play back a disc that is rated PG, PG-13, R, NC-17 or Adult. Setting the unit to Adult will allow any movie to play.

G
PG
PG - 13
R
NC - 17
Adult



The rating level can be changed by entering the default password (3308) and pressing ENTER. To set a new password, key in a new four-digit password and press ENTER.



NOTE: The Default Password is 3308. This password is always effective even after you have selected your own password and changed it. To avoid the possibility of others using the default password to set the parental level and change the password, you can record this default password in another area and delete it from this manual. Some disc content can be limited depending on the age of users while some discs cannot.

1. While in the Rating Setup, use the cursor button ►.
2. Press ENTER for the password prompt.
3. Using the numeric keys enter the password.
4. Press ENTER.
5. Press ► to move the highlight to the different ratings. Press ▲ or ▼ to select the desired rating and then press ENTER to confirm the selection.
6. Press the cursor button ◀ to return to the function setup page.

MISC SETUP

The MISC setup allows the user to reset all options to the factory default settings and enable or disable screen saver.

* This function will not affect the Rating control settings.

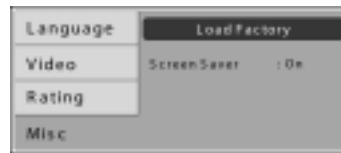

Factory Defaults

1. While in the Misc Setup use the cursor button ►.

2. Press ENTER to move the highlight to the different options for the selected item. Press ◀ or ▶ to select the desired options and then press ENTER to confirm the selection.



3. Press the cursor button ◀ to return to the function setup page.

Screen Saver

NOTE: The DVD unit will activate the screen saver function if the function is enabled and the unit is inactive for three minutes.



1. While in the MISC Setup use the cursor button ▶.
2. Use the ▲ or ▼ to select SCREEN SAVER.
3. Press ▶ to move the highlight to the different options for the selected item. Press ▲ or ▼ to select the desired options and then press ENTER to confirm the selection.

4. Press the cursor button ◀ to return to the function setup page.

Playing Audio CDs

1. When playing an audio CD, the DISPLAY banner appears automatically. It displays the track playing, the total tracks on the disc, and the elapsed time of the track playing.
2. Selecting a Track
You can skip to a specific track by using the number keys. Key in the desired track number and press ENTER.
3. Using the REPEAT feature
The default mode for the REPEAT feature is OFF. Pressing REPEAT consecutively changes the repeat options:
 - SINGLE - repeat the track that is playing.
 - ALL - repeat the entire disc that is playing.
 - OFF - Turns off the Repeat option.

As you toggle through the options, the repeat option changes. The track currently playing repeats once that track has ended. The selected repeat option loops repeatedly until you turn it off.

Playing MP3 Discs

Use the Next (▶▶) button on the remote control to move to the next song. Use the Previous (◀◀) button to move to the previous song.

Selecting a Play Mode

You can choose what order the songs will play on a disc temporarily. The default play mode is FOLDER NORMAL. Press the STOP button, then press ▶ to highlight the play mode. Press the ENTER button consecutively to select the desired play mode. The play mode options are:

- FOLDER NORMAL- Plays all songs in a folder once.
- FOLDER REPEAT- Plays all songs in a folder repetitively.
- DISC NORMAL- Plays entire disc.
- DISC REPEAT- Repeats entire disc.
- SHUFFLE- Plays the songs in a folder in random order from within the selected folder. Each song in a folder can be played once.
- PROGRAM BEGIN/PROGRAM END- Follow the instructions for selecting a play mode. Select PROGRAM BEGIN. Select the desired tracks within the selected folder using the number buttons on the remote control. When all the tracks have been entered press the ENTER button and PROGRAM END is displayed. Press the PLAY button and playback of the programmed tracks will begin.
- SINGLE TRACK- Plays a single track.
- REPEAT SINGLE- Plays a single track repetitively.

MP3 Format

MP3 is a format for storing digital audio. An audio CD song can be compressed into the MP3 format with very little loss of quality while taking up much less space. CD-R discs that have been encoded in MP3 format can be played in the DVD player. The DVD player plays the songs in the order they were burned on to the disc. When play back is started the elapsed time of the track that is playing will be displayed. Press the DISPLAY button to turn the display off.

Selecting Folders and Songs

When an MP3 is loaded in the player, the navigation menu appears automatically.

1. Press ▲ or ▼ to move the highlight to the desired folder on the left side of the Menu and press ENTER. The songs in the folder will be displayed on the right side of the Menu.
2. Press ▲ or ▼ to move the highlight to the desired song and press ENTER to begin playback of the highlighted song.



Program Play

To use the program play option, you must create a play list of songs in the order you want them to play.

NOTE: Once you begin adding songs from a folder to create your play list, you cannot add songs from a different folder.

1. Choose the PROG-PO option for the PLAY MODE.
2. Highlight and enter the folder you want to program.
3. Add songs to the program list by pressing ENTER once the song is highlighted. The song you have chosen and the number of songs you have chosen appear at the top of the screen. For example, if you choose the number five song within the folder and it is the first song you have chosen, PROGRAM P01:05 appears.
4. You can continue to add songs to the list from within the same folder by using the up or down arrow button and then pressing ENTER to add it to the list.
5. When you are done creating the list, press STOP to end the programming, PROG-END is displayed. Then press PLAY to begin the program play mode.

Deleting the Play List

To delete the play list, press stop while the disc is playing and change to another play mode.

Troubleshooting

| PROBLEM | SOLUTION |
|--|---|
| IR Sensor Inoperative (DVD Player Won't Accept Commands From Remote Control) | <ul style="list-style-type: none"> • Verify that the batteries in the remote are fresh. • Verify that the remote sensor eye is not obstructed. • Verify that monitor select M1 or monitor select M2 has been selected correctly on the Remote Control. (When monitor Select M1 is pressed on the Remote Control, the remote will only operate the M1 monitor.) (When monitor Select M2 is pressed on the Remote Control, the remote will only operate the M2 monitor.) |
| Disc Will Not Play or Wrong Region is Displayed | <ul style="list-style-type: none"> • Check the type of disc you put into disc slot. This DVD system only plays digital video discs, audio CDs and MP3s. • Both the unit and the disc are coded by region. If the regional codes don't match, the disc can't be played. This DVD player is set to Region 1. |
| Play Starts, Then Stops Immediately | <ul style="list-style-type: none"> • The disc is dirty. Clean it. • Condensation has formed. Allow player to dry out. • Disc is damaged; try another disc. |
| No Sound or Distorted Sound | <ul style="list-style-type: none"> • If you are using the IR headphones, make sure you turn on the IRT power with the IRT ON/OFF button on the Remote Control. Make sure that the headphone batteries are fresh. • If you are using the vehicle radio, make sure that there is no plug in the vehicle's AUX jack and that the radio is in the AUX mode. |
| OSD Displays "Incorrect Disc Format" | <ul style="list-style-type: none"> • Disc loaded backwards, turn disc around so that the disc label is facing towards the driver. |

FUSE REPLACEMENT

There is one (1) in-line fuse located inside the side front console kick panel (passenger's side). If this fuse is blown, the DVD system cannot be turned on.

The fuse can be easily replaced by prying the kick panel outward, disengaging the clips and removing the kick panel. (See figure 5.)



Figure 5. Accessing the Fuse

SPECIFICATIONS

| | |
|-----------------------|--|
| Display Type | TFT Active Matrix LCD |
| Resolution | 1440(W) x 234 (H) 480 (RGB) (W) x 234 (H) |
| Pixels | 336,960 |
| Aspect Ratio | 16:9 |
| Back Light | Edge Light Tube |
| Backlight life | 10,000 hours |
| Power Source | +12 VDC |
| Power Consumption | 35W For 2 Monitors + 2 DVD |
| Operating Temperature | -4°F ~ 149°F (-20°C ~ +65°C) |
| Storage Temperature | -40°F ~ 185°F (-40°C ~ +85°C) |
| Video Display System | NTSC/PAL |



PT900-52080-OM
128-7907A

For Customer Service Call the
Toll-Free Scion Customer
Experience Center
1-866-707-2466 or
Visit Our Website At
www.scion.com